

Manual Battery Switches

CE **IGNITION PROTECTED**

Available in three sizes and up to five configurations to fit multiple applications.

- Meets American Boat and Yacht Council (ABYC) requirements
- Tin-plated Copper studs for maximum conductivity and corrosion resistance
- 7/8" (22 mm) stud length accepts multiple cable terminals
- Blue Sea System's one-piece terminal stud design never loosens over time
- One-piece stainless flange nuts ensure safe and secure connections
- Accepts up to 4/0 AWG (120 mm²) battery cables
- Tactile indicator conveys knob position by feel
- Case design offers multiple mounting options
- Icon Circuit Identification Label Kit available 7902 - sold separately

TECH TIP

Battery switches isolate the potentially destructive energy in the battery banks when the vehicle is not in use or during emergencies.

ABYC 11.7.1.2.1. A battery switch shall be installed in the positive conductor(s) from each battery or battery bank with a CCA rating greater than 800A

Choose the Dual Circuit Plus™

- Easily manage two battery banks
- When battery bank selection is not necessary
- When using sensitive electronics
- When paired with an Automatic Charging Relay (ACR)

The Dual Circuit Plus is a double pole switch that supplies power to devices connected to a specific battery bank. House electronics are isolated from the start bank. This preserves the start battery and prevents sensitive electronics from being subjected to voltage sags and spikes during starting. Designed for use with an Automatic Charging Relay (ACR) to provide simultaneous charging of two battery banks from the engine's alternator.



M-Series



E-Series



HD-Series

Manual Battery Switches

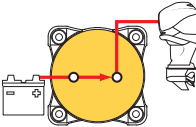
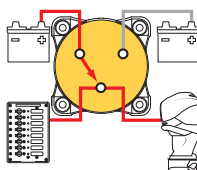
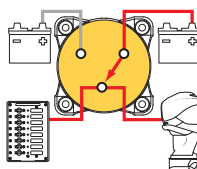

Part #	6004	6005	6006	9003E, 9004E	3000, 3001	6008	11001	11003
Switch Type	Single Circuit ON-OFF					Selector 3 Position		
Switch Family	m-Series		e-Series	HD-Series		m-Series	e-Series	HD-Series
Function	Switches a single battery to a single load group					Switches either isolated battery bank to loads		
Battery Inputs			1			2	2	
Switch Positions			2			3	3	
Battery Combine			--			--	--	
Make Before Break	N/A		N/A		N/A		N/A	
Cranking Rating (30 sec.)	900A		1,200A	1,750A		900A	1,200A	1,600A
Intermittent Rating (5 min.)	500A		600A	900A		500A	600A	700A
Continuous Rating	300A		350A	600A		300A	350A	500A
Voltage Max. Operating	48V DC		48V DC	32V DC		32V DC	32V DC	
Width	2.83" (72 mm)		3.85" (98 mm)			2.83" (72 mm)	3.85" (98 mm)	
Height	2.83" (72 mm)		3.85" (98 mm)			2.83" (72 mm)	3.85" (98 mm)	
Mounting Centers	2.18" (55 mm)		3.00" (76 mm)			2.18" (55 mm)	3.00" (76 mm)	
Mounting Hardware	#10 (M5) Screws		1/4" (M6) Screws			#10 (M5) Screws	1/4" (M6) Screws	
Terminal Stud Size	Ø 3/8"-16 (M10)			Ø 1/2" (M12)		Ø 3/8"-16 (M10)	Ø 3/8"-16 (M10)	Ø 1/2" (M12)
Terminal Stud Length	7/8" (22 mm)					7/8" (22 mm)		
Max. Terminal Stud Torque	120 in-lb (13.56 N-m)		140 in-lb (15.82 N-m)	220 in-lb (24.86 N-m)		120 in-lb (13.56 N-m)	140 in-lb (15.82 N-m)	220 in-lb (24.86 N-m)
Terminal Stud Material	Tin-plated Copper					Tin-plated Copper		
Cable Size to Meet Ratings *	4/0 AWG (120 mm ²)					4/0 AWG (120 mm ²)		
Cable Clearance for 4/0 Cables	1.12" (28.4 mm)		1.10" (27.9 mm)			1.12" (28.4 mm)	1.10" (27.9 mm)	
Ignition Protected	UL 1500, SAE J1171					UL 1500, SAE J1171		
Ingress Protected	IP66					IP66		
These diagrams are intended for reference of how the switches operate and are not wiring diagrams. Consult an ABYC certified marine electrical professional for system design and circuit protection.	 <p>Switch set to ON</p>					 <p>Switch set to 1</p>  <p>Switch set to 2</p>		

* Reducing cable size will reduce current rating



6007			9001E, 9002E		3002, 3003		6010		5510E		6011		5511E	
Selector 4 Position						Dual Circuit™				Dual Circuit Plus™				
m-Series		e-Series		HD-Series		m-Series		e-Series		m-Series		e-Series		
Switches isolated battery banks to all loads or combines battery banks to all loads						Simultaneously switches two isolated battery banks				Simultaneously switches two isolated battery banks or combines battery banks to all loads				
2						2				2				
4						2				3				
Yes						---				Yes				
Yes						---				Yes				
900A		1,200A		1,600A		675A per circuit		700A per circuit		675A per circuit		700A per circuit		
500A		600A		700A		450A per circuit		525A per circuit		450A per circuit		525A per circuit		
300A		350A		500A		300A per circuit		350A per circuit		300A per circuit		350A per circuit		
32V DC						32V DC				32V DC				
2.83" (72 mm)		3.85" (98 mm)				2.83" (72 mm)		3.85" (98 mm)		2.83" (72 mm)		3.85" (98 mm)		
2.83" (72 mm)		3.85" (98 mm)				2.83" (72 mm)		3.85" (98 mm)		2.83" (72 mm)		3.85" (98 mm)		
2.18" (55 mm)		3.00" (76 mm)				2.18" (55 mm)		3.00" (76 mm)		2.18" (55 mm)		3.00" (76 mm)		
#10 (M5) Screws		1/4" (M6) Screws				#10 (M5) Screws		1/4" (M6) Screws		#10 (M5) Screws		1/4" (M6) Screws		
Ø 3/8"-16 (M10)		Ø 3/8"-16 (M10)		Ø 1/2" (M12)		Ø 3/8"-16 (M10)				Ø 3/8"-16 (M10)				
7/8" (22 mm)						7/8" (22 mm)				7/8" (22 mm)				
120 in-lb (13.56 N-m)		140 in-lb (15.82 N-m)		220 in-lb (24.86 N-m)		120 in-lb (13.56 N-m)		140 in-lb (15.82 N-m)		120 in-lb (13.56 N-m)		140 in-lb (15.82 N-m)		
Tin-plated Copper						Tin-plated Copper				Tin-plated Copper				
4/0 AWG (120 mm ²)						4/0 AWG (120 mm ²)				4/0 AWG (120 mm ²)				
1.12" (28.4 mm)		1.10" (27.9 mm)				1.12" (28.4 mm)		1.10" (27.9 mm)		1.12" (28.4 mm)		1.10" (27.9 mm)		
UL 1500, SAE J1171						UL 1500, SAE J1171				UL 1500, SAE J1171				
IP66						IP66				IP66				

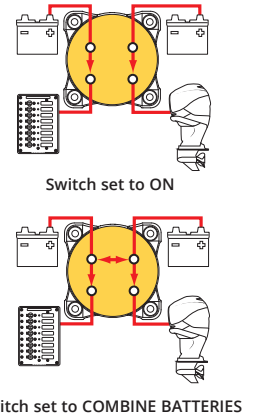
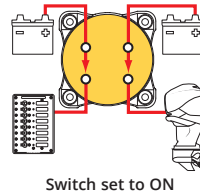
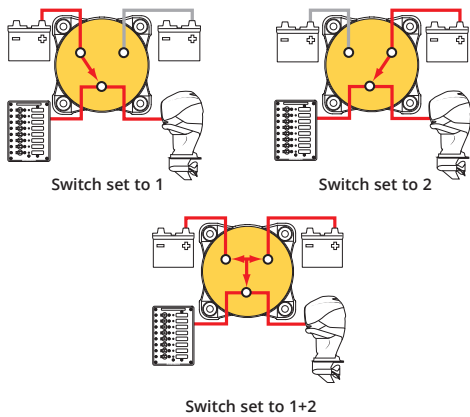

Specs

M-Series Battery Switches

300 Amps continuous rating for outboards and small gasoline or diesel engines

- Isolating cover protects rear contacts
- Back cover breakout tabs allow wire access in any direction
- Rear, front and surface mounting options
- 6 Circuit label set included (not included with 6004, 6005, 6004200, 6005200)

E-Series Battery Switches

350 Amps continuous rating for inboard gasoline or diesel engines

- Rear and front mounting options
- Fits most standard competitors battery switch hole patterns

HD-Series Battery Switches

Up to 600 Amps continuous rating for large diesel engines

- Rear and front mounting options
- Fits most standard competitors battery switch hole patterns

Mounting Options

M-Series



E-Series



HD-Series



M-Series

Part #	Description	Color
6004	Single Circuit ON-OFF & Locking Key	Red
6004200	Single Circuit ON-OFF & Locking Key	Black
6005	Single Circuit ON-OFF & Key	Red
6005200	Single Circuit ON-OFF & Key	Black
6006	Single Circuit ON-OFF	Red
6006200	Single Circuit ON-OFF	Black
6007	Selector 4 Position	Red
6007200	Selector 4 Position	Black
6008	Selector 3 Position	Red
6008200	Selector 3 Position	Black
6010	Dual Circuit™	Red
6010200	Dual Circuit™	Black
6011	Dual Circuit Plus™	Red
6011200	Dual Circuit Plus™	Black

E-Series

Part #	Description	AFD*
5510E	Dual Circuit™	--
5511E	Dual Circuit Plus™	--
9001E	Selector 4 Position	--
9002E	Selector 4 Position	Yes
9003E	Single Circuit ON-OFF	--
9004E	Single Circuit ON-OFF	Yes
11001	Selector 3 Position	Yes

HD-Series

Part #	Description	AFD*
3000	Single Circuit ON-OFF	--
3001	Single Circuit ON-OFF	Yes
3002	Selector 4 Position	--
3003	Selector 4 Position	Yes
11003	Selector 3 Position	Yes

* Includes Alternator Field Disconnect (AFD) which protects the diodes in the alternator in the event of the switch being switched to the OFF position while the engine is running.

M-Series Dimensions

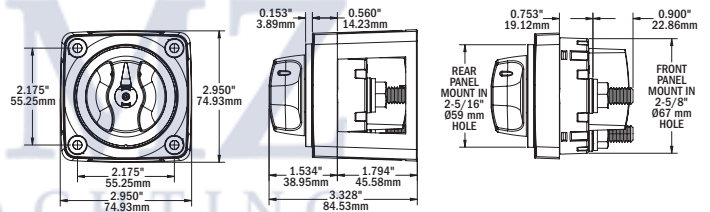

E and HD-Series Dimensions

